

**PR**  
electronics



**5 3 3 3**

**2-Wire Programmable  
Transmitter**

No. 5333V111-UK

From ser. no.:

132094001 - 132094630

141115001 →



**ATEX**



## Revision Notes

The following list provides notes concerning revisions of this document.

<b>Rev. ID</b>	<b>Date</b>	<b>Notes</b>
111	13/45	IECEX and INMETRO approvals added

# 2-WIRE PROGRAMMABLE TRANSMITTER

## PRetop 5333

### Contents

Application.....	2
Technical characteristics.....	2
Mounting / installation .....	2
Applications.....	3
Order: 5333.....	4
Electrical specifications.....	4
Connections .....	7
Block diagram.....	8
Programming .....	9
Mechanical specifications .....	10
Mounting of sensor wires .....	10
Appendix .....	11
ATEX Installation Drawing - 5333A .....	12
ATEX Installation Drawing - 5333D .....	13
IECEX Installation Drawing - 5333A.....	15
IECEX Installation Drawing - 5333D.....	16
FM Installation Drawing - 5333D.....	18
CSA Installation Drawing - 5333D.....	20
INMETRO Instruções de Segurança - 5333A.....	21
INMETRO Instruções de Segurança - 5333D.....	22

## 2-WIRE PROGRAMMABLE TRANSMITTER PRetop 5333

- *RTD or Ohm input*
- *High measurement accuracy*
- *3-wire connection*
- *Programmable sensor error value*
- *For DIN form B sensor head mounting*

### Application

- Linearised temperature measurement with Pt100...Pt1000 or Ni100...Ni1000 sensor.
- Conversion of linear resistance variation to a standard analogue current signal, for instance from valves or Ohmic level sensors.

### Technical characteristics

- Within a few seconds the user can program PR5333 to measure temperatures within all RTD ranges defined by the norms.
- The RTD and resistance inputs have cable compensation for 3-wire connection.

### Mounting / installation

- For DIN form B sensor head mounting. In non-hazardous areas the 5333 can be mounted on a DIN rail with a special fitting.
- **NB:** As Ex barrier for 5333D we recommend 5104B, 5114B, or 5116B.

## APPLICATIONS

RTD to 4...20 mA

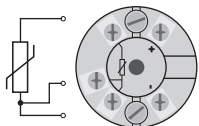

2-wire installation  
in control room

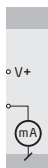

Resistance to 4...20 mA

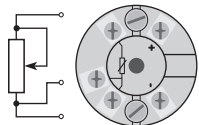

2-wire installation  
in control room

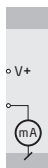

Order: 5333

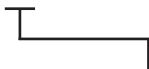

Type	Version
5333	Standard : A CSA, FM, ATEX, IECEx & INMETRO : D

## Electrical specifications

### Specifications range:

-40°C to +85°C

### Common specifications:

Supply voltage, DC

Standard..... 8...35 V

CSA, FM, ATEX, IECEx & INMETRO..... 8...30 V

Internal consumption ..... 25 mW...0.8 W

Voltage drop ..... 8 VDC

Warm-up time..... 5 min.

Communications interface ..... Loop Link

Signal / noise ratio ..... Min. 60 dB

Response time (programmable)..... 0.33...60 s

Signal dynamics, input..... 19 bit

Signal dynamics, output ..... 16 bit

Calibration temperature ..... 20...28°C

Accuracy, the greater of general and basic values:

General values		
Input type	Absolute accuracy	Temperature coefficient
All	$\leq \pm 0.1\%$ of span	$\leq \pm 0.01\%$ of span / °C

Basic values		
Input type	Basic accuracy	Temperature coefficient
RTD	$\leq \pm 0.3^\circ\text{C}$	$\leq \pm 0.01^\circ\text{C}/^\circ\text{C}$
Lin. R	$\leq \pm 0.2 \Omega$	$\leq \pm 20 \text{ m}\Omega / ^\circ\text{C}$

EMC immunity influence .....	$< \pm 0.5\%$ of span
------------------------------	-----------------------

Effect of supply voltage variation.....	≤ 0,005% of span / VDC
Vibration.....	IEC 60068-2-6 Test FC
2...25 Hz.....	±1.6 mm
25...100 Hz.....	±4 g
Max. wire size.....	1 x 1.5 mm <sup>2</sup> stranded wire
Humidity.....	< 95% RH (non-cond.)
Dimensions.....	Ø 44 x 20.2 mm
Protection degree (enclosure / terminal).....	IP68 / IP00
Weight.....	50 g

### Electrical specifications, input:

#### RTD and linear resistance input:

RTD type	Min. value	Max. value	Min. span	Standard
Pt100	-200°C	+850°C	25°C	IEC 60751
Ni100	-60°C	+250°C	25°C	DIN 43760
Lin. R	0 Ω	10000 Ω	30 Ω	-----

Max. offset.....	50% of selec. max. value
Cable resistance per wire (max.).....	10 Ω
Sensor current.....	> 0.2 mA, < 0.4 mA
Effect of sensor cable resistance (3-wire).....	< 0.002 Ω / Ω
Sensor error detection.....	Yes

#### Output:

##### Current output:

Signal range.....	4...20 mA
Min. signal range.....	16 mA
Updating time.....	135 ms
Load resistance.....	≤ (V <sub>supply</sub> - 8) / 0.023 [Ω]
Load stability.....	< ±0.01% of span / 100 Ω

##### Sensor error detection:

Programmable.....	3.5...23 mA
NAMUR NE43 Upscale.....	23 mA
NAMUR NE43 Downscale.....	3.5 mA

Of span = Of the presently selected range

**Approvals:**

EMC 2004/108/EC ..... EN 61326-1  
GOST R

**Marine approval:**

Det Norske Veritas, Ships & Offshore ..... Stand. f. Certific. No. 2.4

**Ex / I.S.:**

ATEX 94/9/EC

5333A..... KEMA 10ATEX0003 X

5333D..... KEMA 03ATEX1535 X

FM certificate ..... 2D5A7

CSA certificate ..... 1125003

IECEX ..... DEK 13.0036 X

INMETRO ..... DEKRA 13.0002 X

GOST Ex



# CONNECTIONS

## Input:

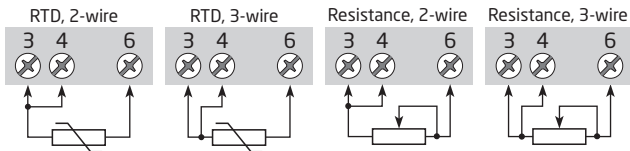

## Output:

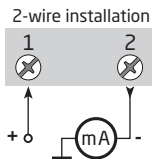

# BLOCK DIAGRAM

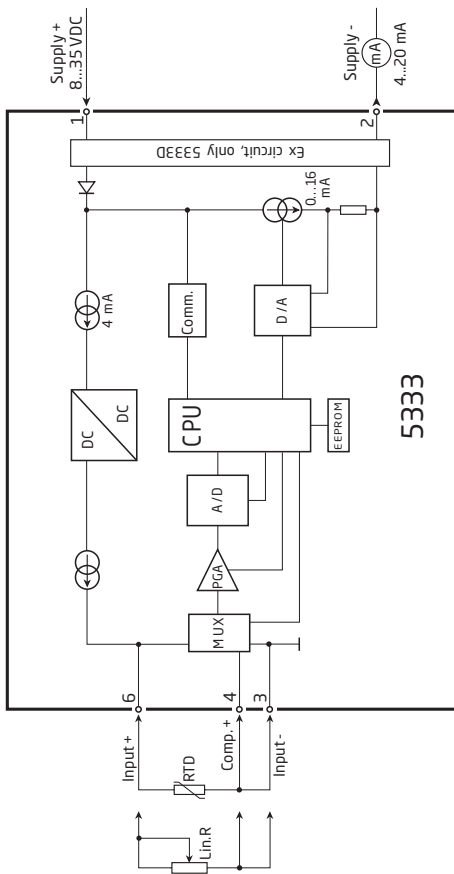

# PROGRAMMING

- Loop Link is a communications interface that is needed for programming PRetop 5333.
- For programming please refer to the drawing below and the help functions in PReset.
- Loop Link is not approved for communication with modules installed in hazardous (Ex) areas.

## Order: Loop Link

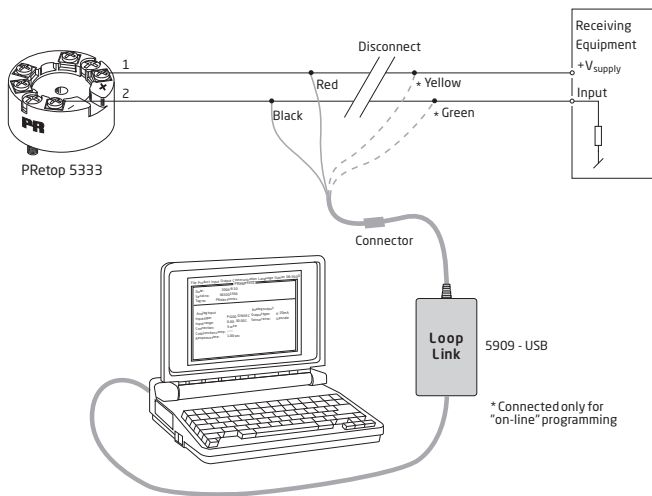

## Mechanical specifications

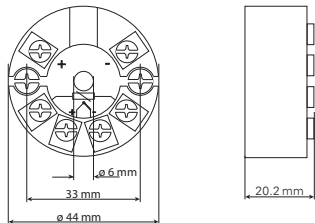

## Mounting of sensor wires

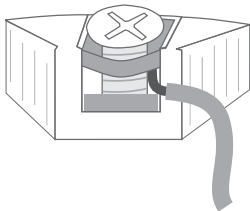

Wires must be mounted between the metal plates.

# APPENDIX

**ATEX Installation Drawing - 5333A**

**ATEX Installation Drawing - 5333D**

**IECEx installation drawing - 5333A**

**IECEx installation drawing - 5333D**

**FM Installation Drawing - 5333D**

**CSA Installation Drawing - 5333D**

**INMETRO Instruções de Segurança - 5333A**

**INMETRO Instruções de Segurança - 5333D**

## ATEX Installation drawing

For safe installation of 5333A the following must be observed. The module shall only be installed by qualified personnel who are familiar with the national and international laws, directives and standards that apply to this area.

Year of manufacture can be taken from the first two digits in the serial number.

ATEX Certificate      KEMA 10ATEX 0003X

Marking  II 3 G Ex nA [ic] IIC T4 ... T6 Gc  
II 3 G Ex ic IIC T4...T6 Gc  
II 3 D Ex ic IIIC Dc

Standards              EN 60079-0 : 2012, EN 60079-11 : 2012, EN 60079-15 : 2010

T4: $-40 \leq T_a \leq 85^{\circ}\text{C}$	<b>Terminal: 3,4,6</b>	<b>Terminal: 1,2</b>	<b>Terminal: 1,2</b>
T6: $-40 \leq T_a \leq 60^{\circ}\text{C}$	Ex nA [ic]	Ex nA	Ex ic
	Uo: 5V	Umax. $\leq 35$ VDC	Ui = 35 VDC
	Io: 4.0 mA		Ii = 110mA
	Po: 20 mW		Li = 10 $\mu\text{H}$
	Lo: 900 mH		Ci = 1.0 nF
	Co: 1000 $\mu\text{F}$		

### Special conditions for safe use

For type of protection Ex nA, the transmitter shall be mounted in a metal enclosure providing a degree of protection of at least IP54 according to EN60529.

For use in the presence of combustible dusts the transmitter shall be mounted in an enclosure providing a degree of protection of at least IP6X in accordance with EN60529, the surface temperature of the outer enclosure is 20 K above the ambient temperature

For an ambient temperature  $\geq 60^{\circ}\text{C}$ , heat resistant cables shall be used with a rating of at least 20 K above the ambient temperature.

## ATEX Installation drawing



For safe installation of 5333D the following must be observed. The module shall only be installed by qualified personnel who are familiar with the national and international laws, directives and standards that apply to this area.

Year of manufacture can be taken from the first two digits in the serial number.

ATEX Certificate KEMA 03ATEX 1535 X

Marking  II 1 G Ex ia IIC T4...T6 Ga  
II 1 D Ex ia IIIC Da  
II 1 M Ex ia I Ma

Standards EN 60079-0 : 2012, EN 60079-11 : 2012, EN 60079-26 : 2007,  
EN 60079-15 : 2010

Hazardous area

Zone 0, 1, 2, 20, 21, 22

T4:  $-40 \leq T_a \leq 85^\circ\text{C}$

T6:  $-40 \leq T_a \leq 60^\circ\text{C}$

**Terminal: 3,4,6**

Uo: 27 VDC

Io: 7 mA

Po: 45 mW

Lo: 35 mH

Co: 90 nF

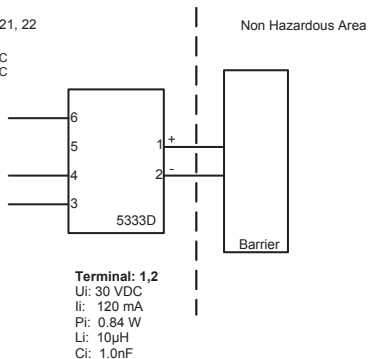

**Installation notes:**

In a potentially explosive gas atmosphere, the transmitter shall be mounted in an enclosure in order to provide a degree of protection of at least IP20 according to EN60529.

If the transmitter is installed in an explosive atmosphere requiring the use of equipment of category 1 G, 1 M or 2 M, and if the enclosure is made of aluminum, it must be installed such that ignition sources due to impact and friction sparks are excluded.

If the enclosure is made of non-metallic materials, electrostatic charging shall be avoided.

For installation in a potentially explosive dust atmosphere, the following instructions apply:

The transmitter shall be mounted in a metal enclosure form B that is providing a degree of protection of at least IP6X according to EN60529, that is suitable for the application and correctly installed.

Cable entries and blanking elements shall be used that are suitable for the application and correctly installed.

For an ambient temperature  $\geq 60^{\circ}\text{C}$ , heat resistant cables shall be used with a rating of at least 20 K above the ambient temperature.

The surface temperature of the enclosure is equal to the ambient temperature plus 20 K, for a dust layer with a thickness up to 5 mm



## IECEx Installation drawing



For safe installation of 5333A or 5343A the following must be observed. The module shall only be installed by qualified personnel who are familiar with the national and international laws, directives and standards that apply to this area.

Year of manufacture can be taken from the first two digits in the serial number.

Certificate	IECEx DEK 13.0036X		
Marking	Ex nA [ic] IIC T6..T4 Gc	T4: $-40 \leq T_a \leq 85^\circ\text{C}$	
	Ex ic IIC T6..T4 Gc	T6: $-40 \leq T_a \leq 60^\circ\text{C}$	
	Ex ic IIIC Dc		
Standards	IEC 60079-0 : 2011, IEC 60079-11 : 2011, IEC 60079-15 : 2010		

Terminal	Ex nA [ic]	Ex ic
1,2	U <sub>max</sub> = 35V	U <sub>i</sub> : 35V, I <sub>i</sub> :110mA, I <sub>i</sub> :10μH, C <sub>i</sub> :1,0nF
3,4,6	U <sub>o</sub> : 5V, I <sub>o</sub> : 4mA, P <sub>o</sub> : 20mW, L <sub>o</sub> : 900mH, C <sub>o</sub> : 1000μF	

### Installation note:

For installation in a potentially explosive gas atmosphere, the following instructions apply:

For nA installation the transmitter must be installed in an metal enclosure e.g. a form B enclosure, providing a degree of protection of at least IP54 according to IEC60529 or in an enclosure with type of protection Ex n or Ex e.

For ic installation the transmitter must be installed in enclosure providing a degree of protection of at least IP20 according to IEC60529 and that is suitable for the application.

Cable entry devices and blanking elements shall fulfill the same requirements

For an ambient temperature  $\geq 60^\circ\text{C}$ , heat resistant cables shall be used with a rating of at least 20 K above the ambient temperature.

For installation in a potentially explosive dust atmosphere, the following instructions apply:

The surface temperature of the enclosure is equal to the ambient temperature plus 20 K, for a dust layer with a thickness up to 5 mm.

The transmitter must be mounted in a enclosure according to DIN 43729 that provides a degree of protection of at least IP6X according to IEC60529, and that is suitable for the application. Cable entry devices and blanking elements shall fulfill the same requirements.

## IECEx Installation drawing



For safe installation of 5333D or 5343B the following must be observed. The module shall only be installed by qualified personnel who are familiar with the national and international laws, directives and standards that apply to this area.

Year of manufacture can be taken from the first two digits in the serial number.

Certificate	IECEx DEK 13.0036X
Marking	Ex ia IIC T4...T6 Ga Ex ia IIC Da Ex ia I Ma
Standards	IEC 60079-0 : 2011, IEC 60079-11 : 2011, IEC 60079-26:2006

Hazardous area  
Zone 0, 1, 2, 20, 21, 22, M1

T4:  $-40 \leq T_a \leq 85^\circ\text{C}$

T5:  $-40 \leq T_a \leq 60^\circ\text{C}$

T6:  $-40 \leq T_a \leq 45^\circ\text{C}$

Non Hazardous Area

**Terminal: 3,4,6**

U<sub>o</sub>: 30 VDC

I<sub>o</sub>: 8 mA

P<sub>o</sub>: 60 mW

L<sub>o</sub>: 35 mH

C<sub>o</sub>: 66 nF

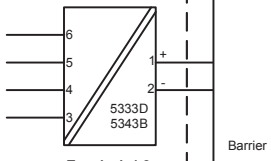

**Terminal: 1,2**

U<sub>i</sub>: 30 VDC

I<sub>i</sub>: 120 mA

P<sub>i</sub>: 0.84 W

L<sub>i</sub>: 10μH

C<sub>i</sub>: 1.0nF

**Installation notes.**

In a potentially explosive gas atmosphere, the transmitter shall be mounted in a metal form B enclosure in order to provide a degree of protection of at least IP20 according to IEC60529. If however the environment requires a higher degree of protection, this shall be taken into account.

If the transmitter is installed in an explosive atmosphere requiring the use of equipment protection level Ga, Ma and Mb, and if the enclosure is made of aluminum, it must be installed such, that ignition sources due to impact and friction sparks are excluded.

For installation in a potentially explosive dust atmosphere, the following instructions apply:

For explosive dust atmospheres, the surface temperature of the outer enclosure is 20 K above the ambient temperature.

The transmitter shall be mounted in a metal enclosure form B according to DIN43729 that is providing a degree of protection of at least IP6X according to IEC60529, that is suitable for the application and correctly installed.

Cable entries and blanking elements shall be used that are suitable for the application and correctly installed.

For an ambient temperature  $\geq 60^{\circ}\text{C}$ , heat resistant cables shall be used with a rating of at least 20 K above the ambient temperature.

## FM Installation Drawing 5300Q502 Rev AH

### Model 5331C, 5331D, 5333C, 5333D and 5343B

#### Hazardous (Classified) Location

Class I, Division 1, Groups, A, B, C, D  
Class I, Zone 0, IIC

Ambient temperature limits  
T4: -40 to +85 deg. Celsius  
T6: -40 to +60 deg. Celsius

Terminal 1, 2  
Vmax or Ui: 30 V  
Imax or Ii: 120 mA  
Pmax or Pi: 0.84 W  
Ci: 1 nF  
Li: 10 uH

Terminal 3, 4, 5, 6  
Only passive, or non-energy storing devices such as RTD's and Thermocouples may be connected.

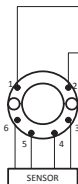

#### Non Hazardous Location

Associated Apparatus  
or Barrier  
with  
entity Parameters:

$UM \leq 250V$   
 $Voc \text{ or } Uo \leq Vmax \text{ or } Ui$   
 $Isc \text{ or } Io \leq Imax \text{ or } Ii$   
 $Po \leq Pi$   
 $Ca \text{ or } Co \geq Ci + Ccable$   
 $La \text{ or } Lo \geq Li + Lcable$

This device must not be connected to any associated apparatus which uses or generates more than 250 VRMS

### Model 5335C, 5335D, 5336D, 5337D

#### Hazardous (Classified) Location

Class I, Division 1, Groups, A, B, C, D  
Class I, Zone 0, IIC

Ambient temperature limits  
T4: -40 to +85 deg. Celsius  
T6: -40 to +60 deg. Celsius

Terminal 1, 2  
Vmax or Ui: 30 V  
Imax or Ii: 120 mA  
Pmax or Pi: 0.84 W  
Ci: 1 nF  
Li: 10 uH

Terminal 3, 4, 5, 6  
Vi or Uo: 9.6 V  
Ii or Io: 28 mA  
Pi or Po: 67.2 mW  
Ca or Co: 3.5 uF  
La or Lo: 35 mH

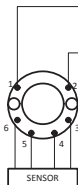

#### Non Hazardous Location

Associated Apparatus  
or Barrier  
with  
entity Parameters:

$UM \leq 250V$   
 $Voc \text{ or } Uo \leq Vmax \text{ or } Ui$   
 $Isc \text{ or } Io \leq Imax \text{ or } Ii$   
 $Po \leq Pi$   
 $Ca \text{ or } Co \geq Ci + Ccable$   
 $La \text{ or } Lo \geq Li + Lcable$

This device must not be connected to any associated apparatus which uses or generates more than 250 VRMS

**The entity concept**

The Transmitter must be installed according to National Electrical Code (ANSI-NFPA 70) and shall be installed with the enclosure, mounting, and spacing segregation requirement of the ultimate application.

Equipment that is FM-approved for intrinsic safety may be connected to barriers based on the ENTITY CONCEPT. This concept permits interconnection of approved transmitters, meters and other devices in combinations which have not been specifically examined by FM, provided that the agency's criteria are met. The combination is then intrinsically safe, if the entity concept is acceptable to the authority having jurisdiction over the installation.

The entity concept criteria are as follows:

The intrinsically safe devices, other than barriers, must not be a source of power.

The maximum voltage  $U_i(V_{MAX})$  and current  $I_i(I_{MAX})$ , and maximum power  $P_i(P_{MAX})$ , which the device can receive and remain intrinsically safe, must be equal to or greater than the voltage ( $U_o$  or  $V_{OC}$  or  $V_i$ ) and current ( $I_o$  or  $I_{SC}$  or  $I_i$ ) and the power  $P_o$  which can be delivered by the barrier.

The sum of the maximum unprotected capacitance ( $C_i$ ) for each intrinsically device and the interconnecting wiring must be less than the capacitance ( $C_a$ ) which can be safely connected to the barrier.

The sum of the maximum unprotected inductance ( $L_i$ ) for each intrinsically device and the interconnecting wiring must be less than the inductance ( $L_a$ ) which can be safely connected to the barrier.

The entity parameters  $U_o, V_{OC}$  or  $V_i$  and  $I_o, I_{SC}$  or  $I_i$ , and  $C_a$  and  $L_a$  for barriers are provided by the barrier manufacturer.

**NI Field Circuit Parameters**

**Model 5331C, 5331D, 5333C, 5333D, 5335C, 5335D, 5336D, 5337D and 5343B**

**Hazardous (Classified) Location**

Class I, Division 2, Groups, A, B, C, D  
Class I, Zone 2, IIC

Ambient temperature limits  
T4: -40 to +85 deg. Celcius  
T6: -40 to +60 deg. Celcius

Terminal 1, 2  
 $V_{max}$ : 35 V  
 $C_i$ : 0  $\mu$ F  
 $L_i$ : 10  $\mu$ H

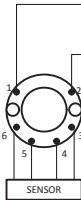

**Non Hazardous Location**

Associated Apparatus  
or Barrier

This device must not be connected to any associated apparatus which uses or generates more than 250 VRMS

## CSA Installation drawing 533XQC03

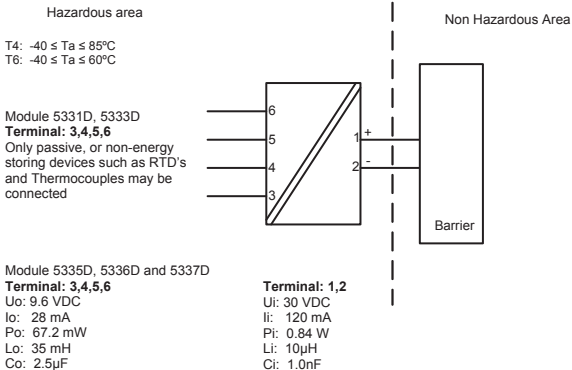

CLASS 2258 04 - PROCESS CONTROL EQUIPMENT - Intrinsically Safe Entity - For Hazardous Locations  
Class I, Division 1, Groups A, B, C and D  
Ex ia IIC, Ga

CLASS 2258 84 - PROCESS CONTROL EQUIPMENT - Intrinsically Safe Entity - For Hazardous Locations - Certified to US Standards  
Class I, Division 1, Groups A, B, C and D  
Class I, Zone 0, AEx ia IIC, Ga

**Warning:**

Substitution of components may impair intrinsic safety.

The transmitters must be installed in a suitable enclosure to meet installation codes stipulated in the Canadian Electrical Code (CEC) or for US the National Electrical Code (NEC).

## Desenho de Instalação InMETRO



Para instalação segura do 5333A ou 5343A o seguinte deve ser observado. O modo deve apenas ser instalado por pessoas qualificadas que são familiarizadas com as leis nacionais e internacionais, diretrizes e padrões que se aplicam a esta área.  
 Ano de fabricação pode ser pego dos dois primeiros dígitos do número de série.

Certificado	IECEX DEK 13.0002 X	
Indicação	Ex nA [ic] IIC T6..T4 Gc	T4: $-40 \leq Ta \leq 85^{\circ}\text{C}$
	Ex ic IIC T6..T4 Gc	T6: $-40 \leq Ta \leq 60^{\circ}\text{C}$
	Ex ic IIIC Dc	

Padrões ABNT NBR IEC 60079-0 : 2008, ABNT NBR IEC 60079-11 : 2009,  
 IEC 60079-15 : 2010, ABNT NBR IEC 60079-26 : 2008

Terminal	Ex nA [ic]	Ex ic
1,2	U <sub>max</sub> = 35V	Ui : 35V, Ii:110mA, Ii:10μH, Ci:1,0nF
3,4,6	Uo: 5V, Io: 4mA, Po: 20mW, Lo: 900mH, Co: 1000μF	

### Notas para instalação

Para a instalação em uma atmosfera de gás potencialmente explosivo, se aplicam as instruções a seguir:

Para a instalação nA o transmissor deve ser instalado em um gabinete de metal, por exemplo, gabinete em forma B que forneça um grau de proteção de pelo menos IP54 de acordo com IEC60529 ou em uma caixa com tipo de proteção Ex n ou Ex e.

Para a instalação iC o transmissor deve ser instalado em um invólucro proporcionando um grau de proteção de IP20, pelo menos, de acordo com a norma IEC60529 que é adequado para a aplicação.

Dispositivos de entrada de cabos e elementos de supressão devem cumprir os mesmos requisitos.

Para uma temperatura ambiente  $\geq 60^{\circ}\text{C}$ , os cabos resistentes ao calor precisam ser utilizados com uma classificação de pelo menos 20 K acima da temperatura ambiente.

Para a instalação em uma atmosfera de poeira potencialmente explosiva, se aplicam as instruções a seguir:

A temperatura da superfície do invólucro é igual à temperatura ambiente mais 20 K, para uma camada de pó, com uma espessura superior a 5 mm.

O transmissor deve ser montado em um invólucro de acordo com a norma DIN 43729, que proporciona um grau de proteção de, pelo menos, IP6X de acordo com a norma IEC60529, e que seja apropriado para a aplicação.

Dispositivos de entrada de cabos e elementos de supressão devem cumprir as mesmas exigências

## Desenho de Instalação InNMETRO



Para instalação segura do 5333D ou 5343B o seguinte deve ser observado. O modo deve apenas ser instalado por pessoas qualificadas que são familiarizadas com as leis nacionais e internacionais, diretrizes e padrões que se aplicam a esta área.  
Ano de fabricação pode ser pego dos dois primeiros dígitos do número de série.

Certificado	DEKRA 13.0002 X
Indicação	Ex ia IIC T6...T4 Ga Ex ia IIIC Da
Padrões	ABNT NBR IEC 60079-0 : 2008, ABNT NBR IEC 60079-11 : 2009, IEC 60079-15 : 2010, ABNT NBR IEC 60079-26 : 2008

### Áreas perigosas

Zona 0, 1, 2, 20, 21, 22, M1

T4:  $-40 \leq T_a \leq 85^\circ\text{C}$

T5:  $-40 \leq T_a \leq 60^\circ\text{C}$

T6:  $-40 \leq T_a \leq 45^\circ\text{C}$

Sem áreas perigosas

### Terminal: 3,4,5,6

Uo: 30 VDC

Io: 8 mA

Po: 60 mW

Lo: 35 mH

Co: 66 nF

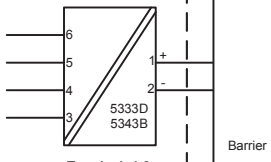

### Terminal: 1,2

Ui: 30 VDC

Ii: 120 mA

Pi: 0,84 W

Li: 10  $\mu\text{H}$

Ci: 1,0 nF



**Notas de Instalação.**

Em uma atmosfera de gás potencialmente explosiva, o transmissor deve ser montado em um enclosure a fim de garantir um grau de proteção de no mínimo IP20 de acordo com EN60529. Se contudo o ambiente requer um nível de proteção maior, isso deve ser levado em conta

Se o transmissor é instalado em uma atmosfera explosiva exigindo o uso de equipamento de categoria Ga e se o enclosure é feito de alumínio, ele deve ser instalado de modo que, mesmo em caso de avaria rara, fontes de ignição devido a impacto e fricção, faíscas são eliminadas; se o enclosure é feito de materiais não metálicos, cargas eletroestáticas devem ser evitadas.

Para instalação em atmosfera de poeira potencialmente explosiva, as instruções a seguir:

O transmissor deve ser montado em enclosure de metal forma B de acordo com DIN43729 que está fornecendo um grau de proteção de pelo menos IP6X de acordo com EN60529. Isso é adequado para aplicação e corretamente instalado.

As entradas dos cabos e os elementos de obturação que podem ser utilizados são adequados para a aplicação e corretamente instalados.

Para temperatura ambiente  $\geq 60^{\circ}\text{C}$ , fios de resistência ao calor devem ser usados com uma faixa de pelo menos 20K acima da temperatura ambiente.

A temperatura da superfície do enclosure é igual à temperatura ambiente mais de 20 K, por uma camada de pó, com uma espessura até 5 mm.



**Displays** Programmable displays with a wide selection of inputs and outputs for display of temperature, volume and weight, etc. Feature linearisation, scaling, and difference measurement functions for programming via PReset software.



**Ex interfaces** Interfaces for analogue and digital signals as well as HART® signals between sensors / I/P converters / frequency signals and control systems in Ex zone 0, 1 & 2 and for some devices in zone 20, 21 & 22.



**Isolation** Galvanic isolators for analogue and digital signals as well as HART® signals. A wide product range with both loop-powered and universal isolators featuring linearisation, inversion, and scaling of output signals.



























**Temperature** A wide selection of transmitters for DIN form B mounting and DIN rail devices with analogue and digital bus communication ranging from application-specific to universal transmitters.



**Universal** PC or front programmable devices with universal options for input, output and supply. This range offers a number of advanced features such as process calibration, linearisation and auto-diagnosis.



- 
 [www.preelectronics.fr](http://www.preelectronics.fr)  
 [sales-fr@preelectronics.com](mailto:sales-fr@preelectronics.com)
- 
 [www.preelectronics.de](http://www.preelectronics.de)  
 [sales-de@preelectronics.com](mailto:sales-de@preelectronics.com)
- 
 [www.preelectronics.es](http://www.preelectronics.es)  
 [sales-es@preelectronics.com](mailto:sales-es@preelectronics.com)
- 
 [www.preelectronics.it](http://www.preelectronics.it)  
 [sales-it@preelectronics.com](mailto:sales-it@preelectronics.com)
- 
 [www.preelectronics.se](http://www.preelectronics.se)  
 [sales-se@preelectronics.com](mailto:sales-se@preelectronics.com)
- 
 [www.preelectronics.co.uk](http://www.preelectronics.co.uk)  
 [sales-uk@preelectronics.com](mailto:sales-uk@preelectronics.com)
- 
 [www.preelectronics.com](http://www.preelectronics.com)  
 [sales-us@preelectronics.com](mailto:sales-us@preelectronics.com)
- 
 [www.preelectronics.cn](http://www.preelectronics.cn)  
 [sales-cn@preelectronics.com](mailto:sales-cn@preelectronics.com)

## Head office

Denmark  
 PR electronics A/S  
 Lerbakken 10  
 DK-8410 Rønde

[www.preelectronics.com](http://www.preelectronics.com)  
[sales-dk@preelectronics.com](mailto:sales-dk@preelectronics.com)  
 tel. +45 86 37 26 77  
 fax +45 86 37 30 85



QUALITY SYSTEM AND ENVIRONMENTAL MANAGEMENT SYSTEM  
 DS/EN ISO 9001  
 DS/EN ISO 14001

